



CABINETS

AUDIO/VIDEO SERIES

NUCOR[®]
DATA SYSTEMS

CABINETS
**AUDIO/VIDEO
SERIES**

- 3** Cabinet Series Overview
- 4** AV Series Cabinets
- 5** Frame & Mounting Rails
- 6** Doors
- 7** Side Panels, Tops, and Bottoms
- 8** Lacing Bars
- 9** Casters & Couplers
- 10** Power Strips
- 11** Fans & PDU Vertical Mounting Bracket

AV SERIES CABINETS

- Narrow 22" wide frames available in four heights and four depths
- All welded 14 gauge steel tubing construction provides a 2500lb. static load rating
- Seismic Zone 4 rated, UL listed
- 19" wide rack mount
- Mounting rails (2pr. included) are tapped #10-32 on EIA 5/8-5/8-1/2" standard spacing and are fully adjustable front to rear
- All are provided with #10-32 screws (bag of 50)
- Optional flush mounted removable side panels secured from inside of cabinet provide optimal security
- Flush mount solid rear door w/ keylock is field reversible without tools
 - Front door-optional
 - Note: If rear door is not required, add "NRD" to end of part number
- Optional flush mount fan top with cable entry knockouts allows for up to (4)110 CFM fans to be placed in cabinet top for maximum cooling
- Open base for raised floor ventilation option
- Grounding stud installed in base of cabinet frame
- Cable entry knockouts in rear skirt of frame
- Bottom corners gusseted with both seismic tiedown and caster mount features
- Four point leveling
- Frames can be bayed together with optional top mount frame coupler (SC-FC)
- Black powder coat finish (BK)

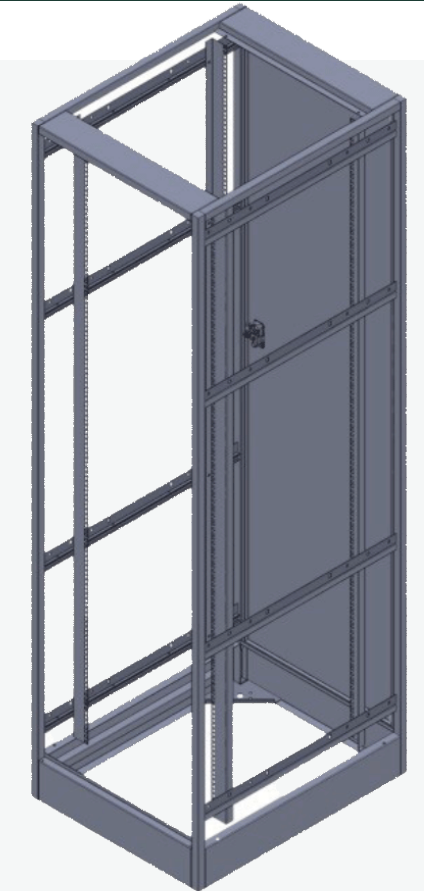

AV CABINET INCLUDES

- (1) Frame
- (2pr) Tapped Rails
- (1) Solid Read Door

23U	37U	42U	44U
AV48X24BK	AV72X24BK	AV78X24BK	AV84X24BK
AV48X30BK	AV72X30BK	AV78X30BK	AV84X30BK
AV48X36BK	AV72X36BK	AV78X36BK	AV84X36BK
AV48X42BK	AV72X42BK	AV78X42BK	AV84X42BK

No Rear Door Required: Add "NRD" to part number e.g. AV84X36BK-NRD

AUDIO/VIDEO SERIES

AUDIO/VIDEO SERIES

AV SERIES CABINETS

- Fully welded steel tubing frames available in 4 heights and 4 depths
- 19" RM, 22" wide
- Leveling feet included with frame
- Bottom corners gusseted for seismic tiedown
- Cable entry knockouts in rear skirt of frame
- Seismic Zone 4 rated, UL listed
- 2500lb. static load rating
- Mounting rails (2pr. included) are tapped #10-32 on EIA 5/8-5/8-1/2" standard spacing and are fully adjustable front to rear. All are provided with # 10-32 screws (bag of 50)
- Flush mount top with (4) 110CFM fans and thermostat kit installed
- Cable entry knockouts in each corner of flush mount top
- Flush mount side panels are removable from inside of cabinet for optimal security
 - Note: If side panels are not required, add "NS" to end of part number
- Flush mount solid front & rear doors w/ key locks are field reversible without tools
- Rear door has bottom vents
- Accessories include:
 - Vertical Lacing Bar (qty. 1)
 - Qty. (4) straight Horizontal Lacing Bars Y Qty. (2) 4" offset Horizontal Lacing Bars
 - Qty. (12) Velcro Straps
 - 20 AMP Vertical Power Strip w/ cord
 - Top mount frame coupler (if no side panels required)



V6 CABINET INCLUDES

- (1) Frame
- (2pr) Tapped Rails
- (2) Solid Side Panels
- (1) Top w/ (4) Fans & Thermostat kit (1) Solid Rear Door w/ bottom vents (1) Solid Front door
- (1) Vertical Lacing Bar
- (6) Horizontal Lacing Bars
- (12) Velcro Straps
- (1) 20 AMP Power Strip

No Side Panels Required:
Add "NSP" to part number
e.g. AV48X30-V6BKNSP

FRAME

- 22" wide frames, 19" wide rack mount
- Available in 4 heights and 4 depths
- All welded 14 gauge steel tubing provides a 2500lb. static load rating
- Bottom corner gussets for caster mounts or seismic tie down points
- Cable entry knockouts in rear skirt of frame
- Frames are Seismic Zone 4 rated, UL listed
- Grounding stud installed in base of cabinet frame
- All frames include leveling feet
- Black powder coat finish

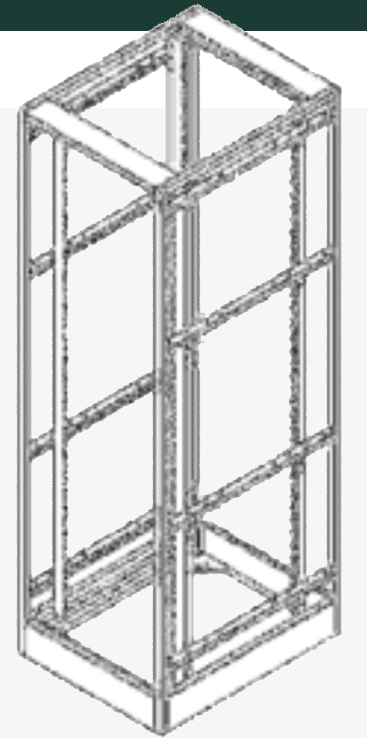

AV SERIES FRAME WITH RAILS

MOUNTING RAILS

- 12 gauge steel mounting rails available in Tapped (Standard) or Cage Nut Versions
- Sold separately in pairs includes appropriate mounting hardware when ordered with cabinet frame - bag of (50) #10-32 screws or cage nuts and screws

FRAME & MOUNTING RAIL PART NUMBERS (HxWxD)

HEIGHT	24" D	30" D	36" D	42" D	MOUNTAIN RAILS
48"H (23U)	FR-AV48X22X24BK	FR-AV48X22X30BK	FR-AV48X22X36BK	FR-AV48X22X42BK	Use SWE740-CN-1 (Cage Nut) OR SWE740-1 (Tapped)
72"H (37U)	FR-AV72X22X24BK	FR-AV72X22X30BK	FR-AV72X22X36BK	FR-AV72X22X42BK	Use SWE740-CN-1 (Cage Nut) OR SWE740-1 (Tapped)
78"H (42U)	FR-AV78X22X24x	FR-AV78X22X30x	FR-AV78X22X36x	FR-AV78X22X42x	Use SWE740-CN-1 (Cage Nut) OR SWE740-1 (Tapped)
84"H (44U)	FR-AV84X22X24BK	FR-AV84X22X30BK	FR-AV84X22X26BK	FR-AV84X22X42BK	Use SWE740-CN-1 (Cage Nut) OR SWE740-1 (Tapped)

23U	37U	42U	44U
AV48X24-V6BK	AV72X24-V6BK	AV78X24-V6BK	AV84X24-V6BK
AV48X30-V6BK	AV72X30-V6BK	AV78X30-V6BK	AV84X30-V6BK
AV48X36-V6BK	AV72X36-V6BK	AV78X36-V6BK	AV84X36-V6BK
AV48X42-V6BK	AV72X42-V6BK	AV78X42-V6BK	AV84X42-V6BK

AUDIO/VIDEO SERIES

AUDIO/VIDEO SERIES

DOORS

- Flush mount doors are field reversible without tools, right to left hand swing
- Carbon steel all welded construction for strength
- All AV doors are equipped with key locks
- Optional Perforated, Split, Plexiglas, Vented or Solid versions
- Black powder coat finish



PERFORATED DOORS

SOLID DOOR

DOOR STYLE	48" H FRAME	72" H FRAME	78" H FRAME	84" H FRAME
Perforated	DPRF-AV42X20BK	DPRF-AV66X20BK	DPRF-AV72X20BK	DPRF-AV78X20BK
Split Perforated	DPRF-AV42X20-2BK	DPRF-AV66X20-2BK	DPRF-AV72X20-2BK	DPRF-AV78X20-2BK
Plexiglas	DPLX-AV42X20BK	DPLX-AV66X20BK	DPLX-AV72X20BK	DPLX-AV78X20BK
Solid	DSTL-AV42X20BK	DSTL-AV66X20BK	DSTL-AV72X20BK	DSTL-AV78X20BK
Vented	DSTLV-AV42X20BK	DSTLV-AV66X20BK	DSTLV-A72X20BK	DSTLV-A78X20BK

SIDE PANELS

- Flush mount side panels secured from inside for optimum security
- Constructed from carbon steel
- Optional Quick Release locking latches available
- Optional solid or vented versions
- Black powder coat finish

HEIGHT	24" DEEP	30" DEEP	36" DEEP	42" DEEP
48" H (23U)	SP-A42X22BK	SP-A42X28BK	SP-A42X34BK	SP-A42X40BK
72" H (37U)	SP-A66X22BK	SP-A66X28BK	SP-A66X34BK	SP-A66X40BK
78" H (42U)	SP-A72X22BK	SP-A72X28BK	SP-A72X34BK	SP-A78X40BK
84" H (44U)	SP-A78X22BK	SP-A78X28BK	SP-A78X34BK	SP-A78X40BK

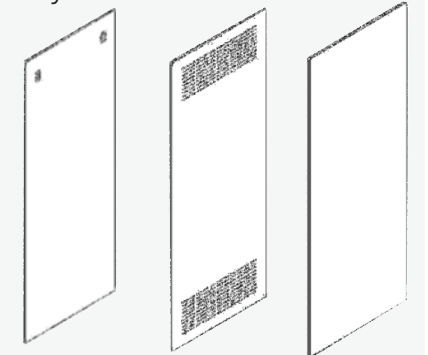

SIDE PANELS

CABINET TOPS

- Flush mount tops available in 3 styles for 22" wide frames:
 - Top with Fan Holes
 - Solid
 - Perforated
- Fan tops have (4) fan holes for 30"D, 36"D, and 42"D frames
- Fan tops for 24"D cabinets have (2) fan holes
- Fan holes have easily removable covers when fans not required
- Solid and Fan Tops have cable entry knock outs in each corner

TOP STYLE	24" DEEP	30" DEEP	36" DEEP	42" DEEP
Fan Top	FMT-AV20X16-FHBK	FMT-AV20X22-FHBK	FMT-AV20x28-FHBK	FMT-AV20X34-FHBK
Solid Top	FMT-AV20X16BK	FMT-A20X22BK	FMT-AV20X28BK	FMT-AV20X34BK
Perforated Top	FMT-AV20X16-PRFBK	FMT-AV20X22-PRFBK	FMT-AV20X28-PRFBK	FMT-AV20X34-PRFBK

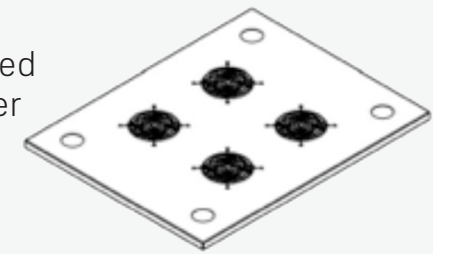

FLUSH MOUNT FAN TOP

CABINET BOTTOMS

- Available for 22"W and in 4 depths
- Prevents airflow from entering the bottom of the cabinet
- 24"D versions have (2) covered fan holes, deeper versions have (4) covered fan holes (part # 19155K23 if filter is required for fan hole)
- Includes cable entry holes with covers

24" DEEP	30" DEEP	36" DEEP	42" DEEP
FMB-AV22X24-FHBK	FMB-AV22X30-FHBK	FMB-AV22x36-FHBK	FMB-AV22X42-FHBK

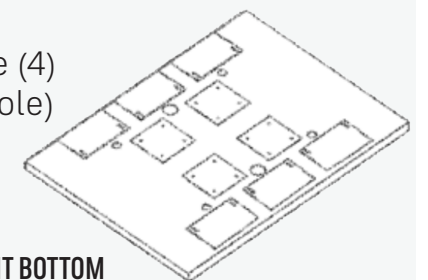

FLUSH MOUNT BOTTOM

AUDIO/VIDEO SERIES

HORIZONTAL LACING BARS

- Steel construction with multiple cable tie slots
- Available in straight bar, 2", 4" and 6" offsets
- Sold in packages of (10)
- Black powder coat finish

PART #	DESCRIPTION
SWE-LB	Horizontal Lacing Bar - straight
SWE-LB2	Horizontal Lacing Bar - 2" offset
SWE-LB4	Horizontal Lacing Bar - 4" offset
SWE-LB6	Horizontal Lacing Bar - 6" offset
SWE-RLB1.5	Round Horizontal Lacing Bar - 1.5" offset

Note: Sold in packs of (10) only



VERTICAL CABLE LACING BAR

- Neatly organizes cable bundles with slots provided for Velcro or other cable straps
- Creates quick cable management solutions for any NDS cabinet series
- Available in 4 heights, 3.5" wide
- Formed 16 gauge steel construction
- Black powder coat finish

PART #	DESCRIPTION
SWE-LB	Horizontal Lacing Bar - straight
SWE-LB2	Horizontal Lacing Bar - 2" offset
SWE-LB4	Horizontal Lacing Bar - 4" offset
SWE-LB6	Horizontal Lacing Bar - 6" offset
SWE-RLB1.5	Round Horizontal Lacing Bar - 1.5" offset

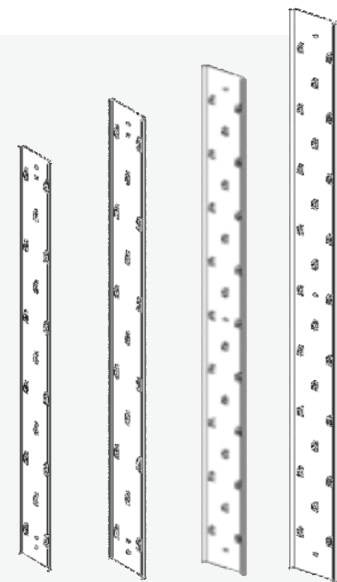

VERTICAL CABLE LACING BAR

AUDIO/VIDEO SERIES

CASTERS: SWE-ACS

- Heavy duty roller bearing construction rated for 1000lbs. per set
- Mounts to any SC Series frame
- Full swivel



FRAME COUPLERS: SC-FC

- Top mount frame couplers install easily to factory pre-drilled frames
- Flat plate 2"Wx18" long enables (2) SC Series frames of the same height and depth to be bayed together
- Enables bayed units to be centered on raised floor tiles (no space between frames)
- Includes installation hardware
- Black (BLK) powder coat finish

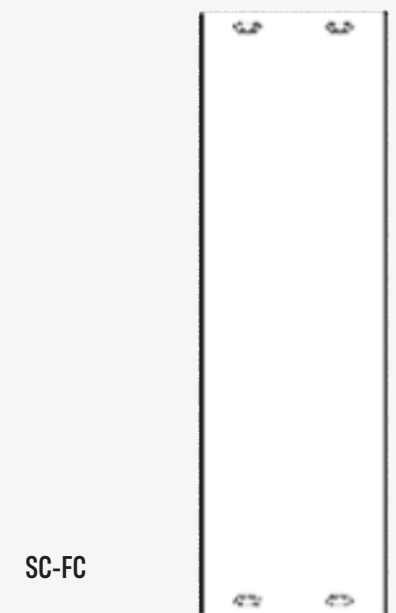

AUDIO/VIDEO SERIES

AUDIO/VIDEO SERIES

POWER STRIPS

- Breaker protected, UL Listed
- Metal construction for durability

15 AMP	DESCRIPTION
SWE705-10TL	(10) 15 AMP outlets, 48"L, 15' cord, Twist Lock Plug
SWE705-16	(16) outlets, 48"L, 15' cord
SWE705-24-15A	(24) outlets, 70"L, 15' cord
SWE705-8	(8) outlets, 44"L, 15' cord
SWE705-RM	Rack Mount, (8) outlet, 15' cord

20 AMP	DESCRIPTION
SWE705-10-15TL	(10) outlets, 15' cord, L5P20 Twist Lock Plug, 48"L
SWE705-10-20A	(14) outlets, 15' cord, 20A plug, 48"L
SWE705-10-20ATL	(14) outlets, 15' cord, L5P20 Twist Lock Plug, 48"L
SWE705-24-20A	(24) outlets, 15' cord, 20A plug, 70"L
SWE705-24-20ATL	(24) outlets, 15' cord, L5P20 Twist Lock plug, 70"L
SWE705-20R-RM	Rack Mount, (8) outlet, 15 ft. cord

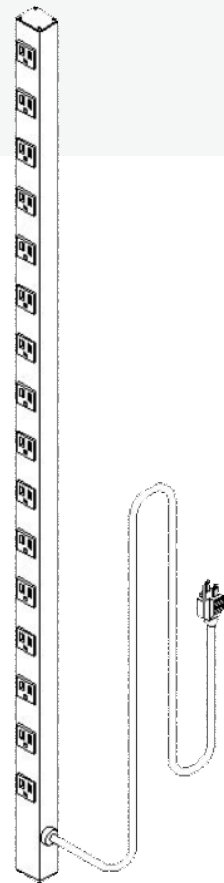

VERTICAL MOUNT POWER STRIP

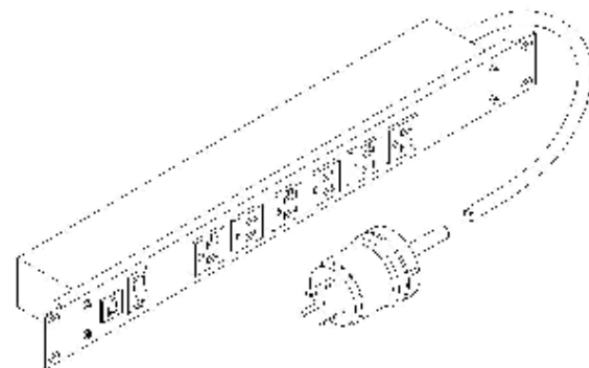

RACK MOUNT POWER STRIP

FANS: SWE706 SERIES

- Can be mounted in any NDS fan top or wall mount cabinet with fan holes
- Sealed bearings
- (2) finger guards included

PART #	DESCRIPTION
SWE706-2	(2) 110 CFM Axial Fans with 6' cord, 115V
SWE706-4	(4) 110 CFM Axial Fans with 6' cord, 115V
SWE706	110 CFM Axial Fan with 6' cord, 115V

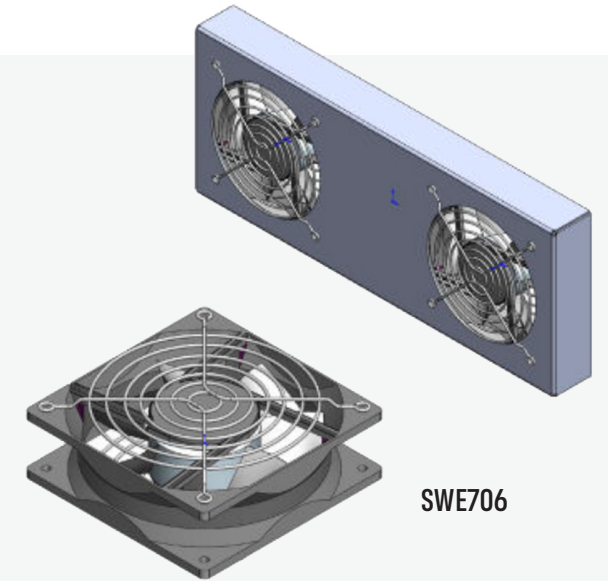

SWE706

PDU VERTICAL MOUNTING BRACKET

- Available in 3 heights
- Full length bracket attaches to cabinet frame to provide options for mounting vertical power distribution units
- Provides tie points for power cords
- Black powder coat finish

PART #	DESCRIPTION
SC-PDUBK-45U	PDU Vertical Mounting Bracket 77"
SC-PDUBK-42U	PDU Vertical Mounting Bracket 73.5"
SC-PDUBK-37U	PDU Vertical Mounting Bracket 64.75"

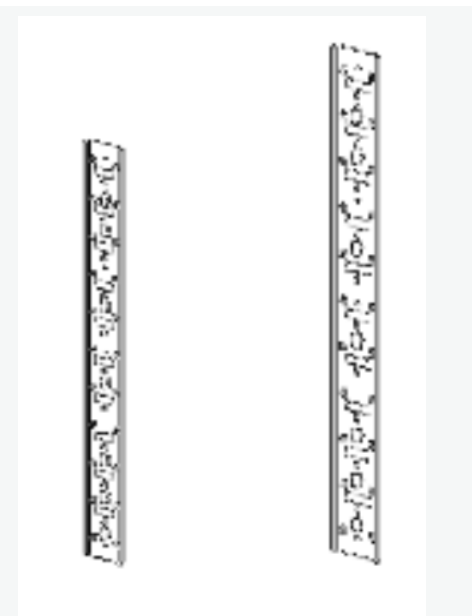

PDU MOUNTING BRACKETS



NUCOR[®]
DATA SYSTEMS

TEL: 909-796-6200

FAX: 909-796-6223

sales@nucordatasystems.com

1385 S Tippencanoe Ave., San Bernardino, CA 92408

NUCORDATASYSTEMS.COM